

# DARI-KOOL®

## BULK MILK COOLERS

Fall Harvest Special  
**NEW BULK MILK TANKS**  
**25% OFF**  
 Sept. 13 thru 20

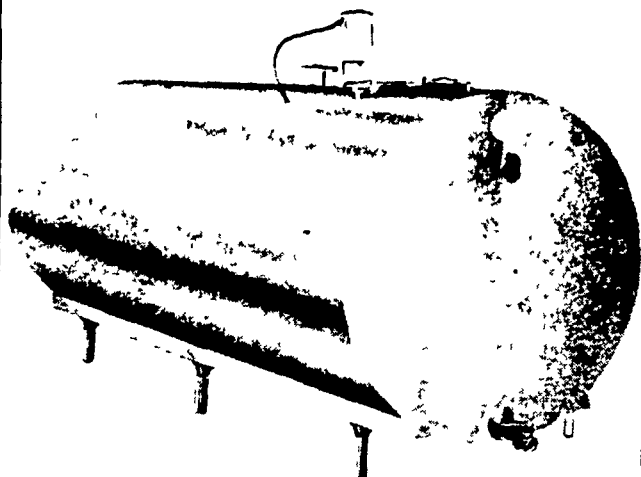

Model DKE Direct Expansion  
 450 to 3000 Gal. Tank

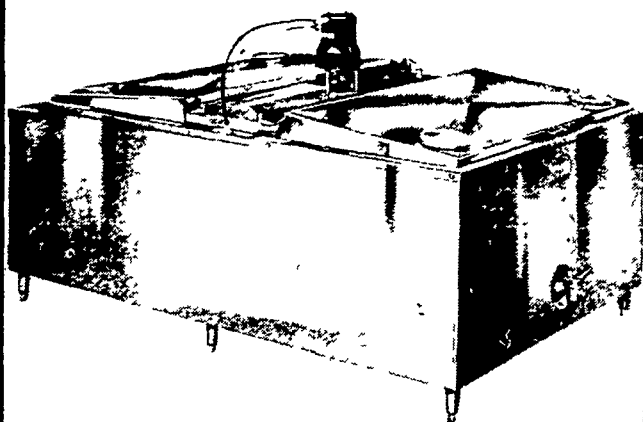

Model DKS Ice Bank  
 400-500-650 Gal.

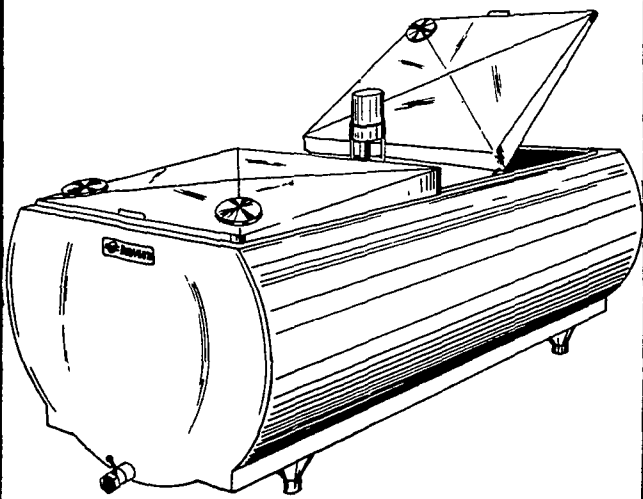

Model DKO Direct Expansion  
 Available - 500 Gal. Only  
 Special Diesel Operated Milk Tank

We are Authorized Dealers for Klenz-Aid Line Bulk Tank Cleaning Products. Buy in Quantity and Receive Big Discounts.

**COMPLETE PROGRAM**  
**SALES — INSTALLATION — SERVICE**  
**24-HOUR SERVICE OFFERED**

All Service Work Guaranteed

## SHENK'S FARM SERVICE

501 E. Woods Drive, Lititz, Pa.  
 626-1151 or 626-5996  
 or Answering Service  
 717-733-1224



Reserve junior and reserve grand champion Angus bull at the 1975 Ohio State Fair, Columbus, was this partnership entry of Pennsylvania State University, University Park and James Neikirk, Springfield, Ohio. The winner was PS Great Northern 064. Photo by American Angus Association.

## It'll burn fewer dollars with a Vent-O-Matic Watt-Watcher Package Fan

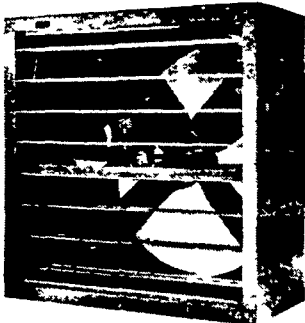
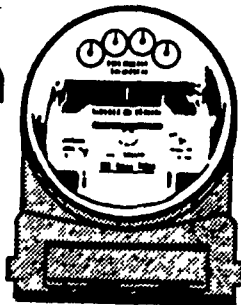

THIS IS THE NEW VENT-O-MATIC WATT-WATCHER

Wind tunnel research shows that ordinary fans can cost up to 58% more than Vent-O-Matic to move the same volume of air. In new buildings, or old, Vent-O-Matic Watt-Watcher package fans use less electricity every working hour, day and night.

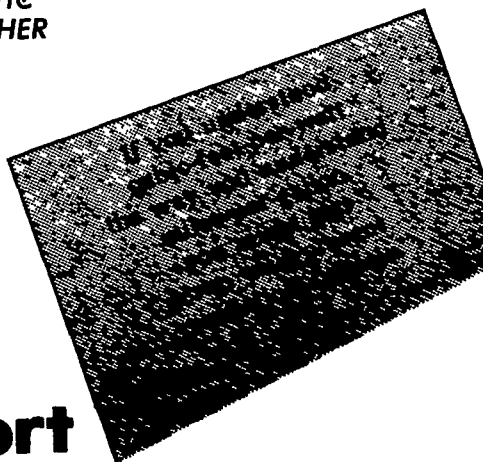

**free report**

spells out the details...tells you how the 1975 Vent-O-Matic line can slash your electric bill while providing healthful, well-balanced air flow. It includes actual performance data on models of five major fan manufacturer. Vent-O-Matic's reputation has been outstanding performance. Now Vent-O-Matic Watt-Watchers deliver outstanding operating economy. Send today for free copy.

Mr. Robert Mieczkowski, President  
 Tuscarora Electric Mfg. Co.  
 Tunkhannock, Pa. 18657

Please send your new Cubic-Feet-Per-Watt performance report immediately

Name \_\_\_\_\_

Street or Address \_\_\_\_\_

City/Town \_\_\_\_\_ State \_\_\_\_\_ Zip \_\_\_\_\_

My interest is ( ) Dairy ( ) Poultry  
 ( ) Hog ( ) Veal

**VENT-O-MATIC OWNERS**

Modification kits soon available for all 1962 and later models. Check here for information. ( )

## Bicentennial coins for sale

WASHINGTON - Director of the Mint Mary Brooks announced a new and innovative marketing program developed expressly for the purpose of providing the greatest number of Americans an opportunity to participate in our nation's Bicentennial Celebration through coins. The Bank Bulk Rate Program has been designed to comply with Public Law 93-127 in which Congress authorized a new coinage design emblematic of the American Revolution for the dollar, half dollar and quarter and the minting of 45 million of these coins of 40 percent silver.

The colonial drummer boy, Independence Hall and the Liberty Bell and Moon are the three designs chosen in a national competition to appear on the backs of the Washington quarter, Kennedy half dollar and Eisenhower dollar

respectively. The double date of 1776-1976 is on the front of the coins. A

Bicentennial set of these three 40 percent silver uncirculated coins retails for \$9.00. The 40 percent silver coins in these Bicentennial uncirculated sets are distinguished from regular circulating coins which are 92 percent copper and 8 percent nickel.

The Mint put into effect on Sept. 11 a distribution and over-the-counter sales program through the nation's 42,000 financial institutions and their 73,000 facilities for these 40 percent silver uncirculated Bicentennial coin sets. The program offers the nation's commercial banks, savings and loan associations, mutual savings associations and credit unions an opportunity to purchase bulk orders of 50 sets and multiples thereof at \$7.00 per set.

## LEID'S DIESEL SERVICE

RD3, New Holland

Ph. (717) 354-8024

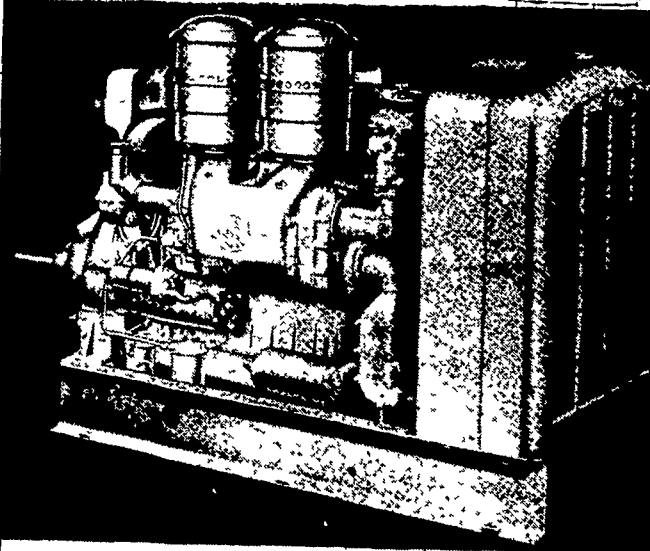

Detroit Diesel Power Unit for use in

- IRRIGATION
- SAW MILLS
- FEED MILLS
- GENERATOR SETS

Complete Sales, Parts & Service

AUTHORIZED DISTRIBUTOR FOR:

- + K.C.G.M. Diesel Parts
- + Fleet Guard Filters
- + Gates V-Belts & Hoses